

## Technical Data Sheet

### Photocoupler

---

### EL815 Series

#### Features:

- Current transfer ratio  
(CTR:MIN.600% at  $I_F = 1\text{mA}$ ,  $V_{CE} = 2\text{V}$ )
- High isolation voltage between input and output ( $V_{iso} = 5000\text{ V rms}$ )
- Compact dual-in-line package  
EL815:1-channel type
- Pb free
  
- UL approved (No. E214129)
- VDE approved (No. 132249)
- SEMKO approved (No. 0227193/01)
- NEMKO approved (No. P00102385)
- DEMKO approved (No. 310352-04)
- FIMKO approved (No. FI 16763A2)
- CSA approved (No. 1143601)
  
- Options available:
  - Leads with 0.4"(10.16mm) spacing (M Type)
  - Leads bends for surface mounting (S Type)
  - Tape and Reel of Type I for SMD(Add"-TA" Suffix)
  - Tape and Reel of Type II for SMD(Add"-TB" Suffix)
  - The tape is 16mm and is wound on a 33cm reel

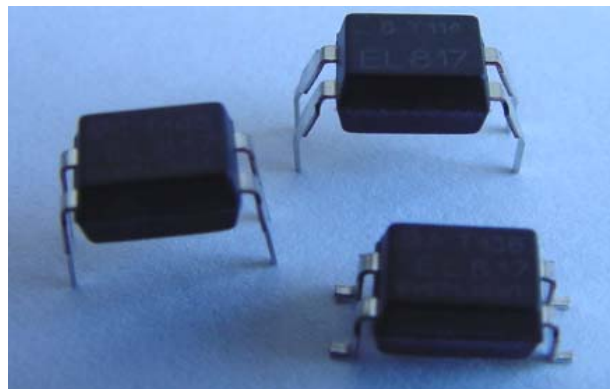

#### Applications

- Telephone sets, telephone exchangers
- Sequence controllers
- System appliances, measuring instruments
- Signal transmission between circuits of different potentials and impedances

# Technical Data Sheet

## Photocoupler

### Device Selection Guide

### EL815 Series

Part. No.	Chip Material	
	IR	PT
EL815	GaAs	Silicon

### Package Dimensions

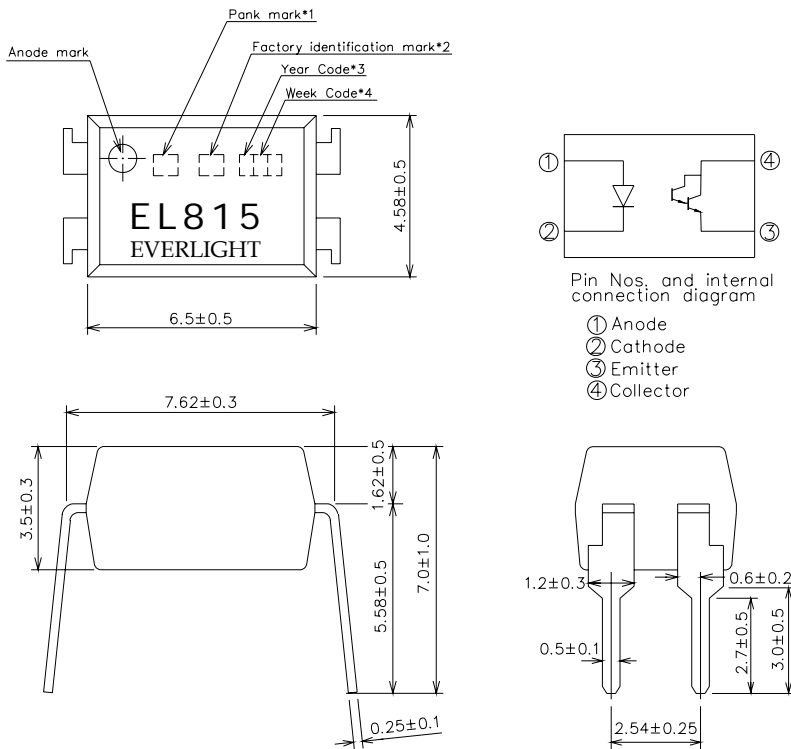

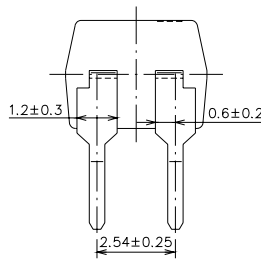
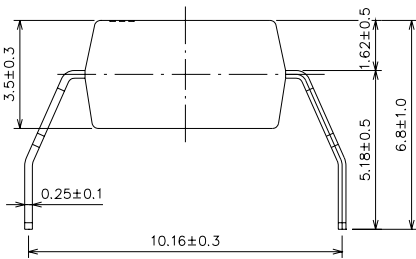
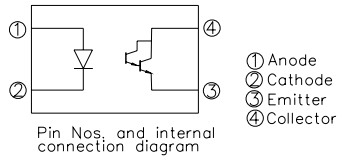
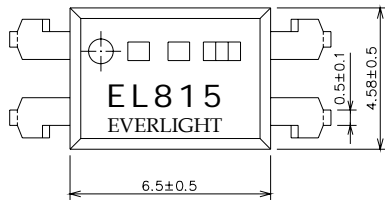
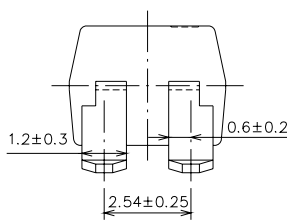
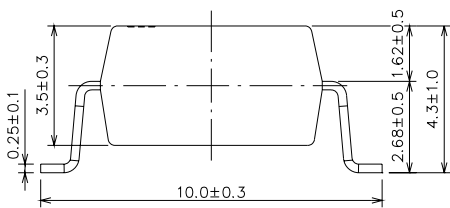
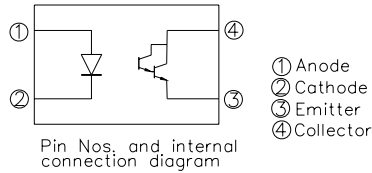
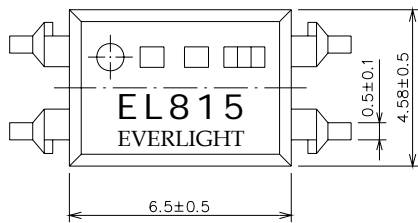
**Technical Data Sheet  
Photocoupler**
**EL815 Series**
**Package Dimensions**
**M type**

**S type**

**Notes:**

1. Rank shall be or shall not be marked
2. Factory code shall be marked (T: Taiwan / C: China)
3. Year date code
4. 2-digit work week
5. All dimensions are in millimeters
6. Specifications are subject to change without notice

**Technical Data Sheet  
Photocoupler**
**EL815 Series**
**Absolute Maximum Ratings**
**( Ta=25°C )**

Parameter		Symbol	Rating	Unit
Input	Forward Current	$I_F$	50	mA
	Reverse Voltage	$V_R$	6	V
	Power Dissipation	$P$	70	mW
Output	Collector Power Dissipation	$P_C$	150	mW
	Collector Current	$I_C$	80	mA
	Collector-Emitter Voltage	$V_{CEO}$	35	V
	Emitter-Collector Voltage	$V_{ECO}$	6	V
Total Power Dissipation		$P_{tot}$	200	mW
*1 Isolation Voltage		$V_{iso}$	5000	V rms
Operating Temperature		$T_{opr}$	-55~+110	°C
Storage Temperature		$T_{stg}$	-55~+125	°C
*2 Soldering Temperature		$T_{sol}$	260	°C

\*1 AC for 1 minute, R.H= 40~ 60%RH

-Isolation voltage shall be measured using the following method.

- (1) Short between anode and cathode on the primary side and between collector, emitter and base on the secondary side.
- (2) The isolation voltage tester with zero-cross circuit shall be used.
- (3) The waveform of applied voltage shall be a sine wave

\*2 For 10 seconds

**Technical Data Sheet  
Photocoupler**
**EL815 Series  
(Ta=25°C)**
**Electro-Optical Characteristics**

Parameter		Symbol	Min.	Typ.	Max.	Unit	Condition
Input	Forward	$V_F$	-	1.2	1.4	V	$I_F=20\text{mA}$
	Reverse Current	$I_R$	-	-	10	$\mu\text{A}$	$V_R=4\text{V}$
	Terminal	$C_t$	-	30	250	pF	$V=0, f=1\text{kHz}$
Output	Collector Dark current	$I_{CEO}$	-	-	1	$\mu\text{A}$	$V_{CE}=10\text{V}$
	Collector-Emitter breakdown voltage	$BV_{CEO}$	35	-	-	V	$I_c=0.1\text{mA}$
Transfer Characteristics	Current Transfer ratio	CTR	600	-	7,500	%	$I_F=1\text{mA}, V_{CE}=2\text{V}$
	Collector-Emitter saturation voltage	$V_{CE(sat)}$	-	0.8	1.0	V	$I_F=20\text{mA}, I_c=5\text{mA}$
	Isolation resistance	$R_{ISO}$	$5 \times 10^{10}$	$10^{11}$	-	$\Omega$	DC500V, 40~60%R.H
	Floating capacitance	$C_f$	-	0.6	1.0	pF	$V=0, f=1\text{MHz}$
	Cut-off frequency	$f_c$	1	6	-	kHz	$V_{CE}=5\text{V}, I_c=2\text{mA}$ $R_L=100\Omega, -3\text{dB}$
	Rise time	$t_r$	-	60	300	$\mu\text{s}$	$V_{CE}=2\text{V}$ $I_c=10\text{mA}, R_L=100\Omega$
	Fall time	$t_f$	-	53	250	$\mu\text{s}$	

Technical Data Sheet  
Photocoupler

**EL815 Series**

Typical Electrical / Optical Characteristic Curves  
( 25°C Ambient Temperature Unless Otherwise Noted)

Fig. 1 Forward Current vs. Ambient Temperature

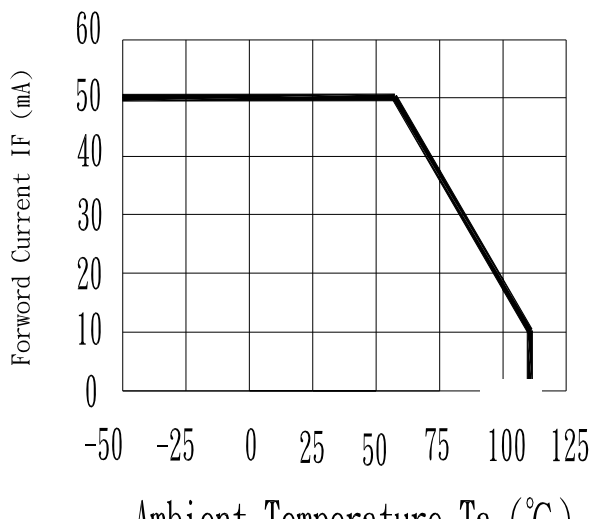

Fig.2 Collector Power Dissipation vs. Ambient Temperature

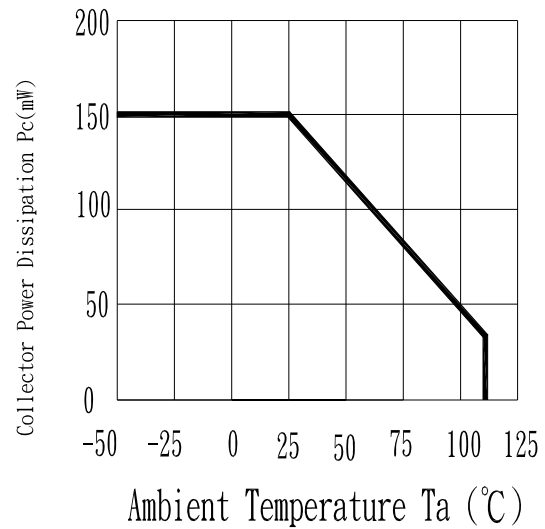

Fig. 3 Collector-emitter Saturation Voltage vs. Forward Current

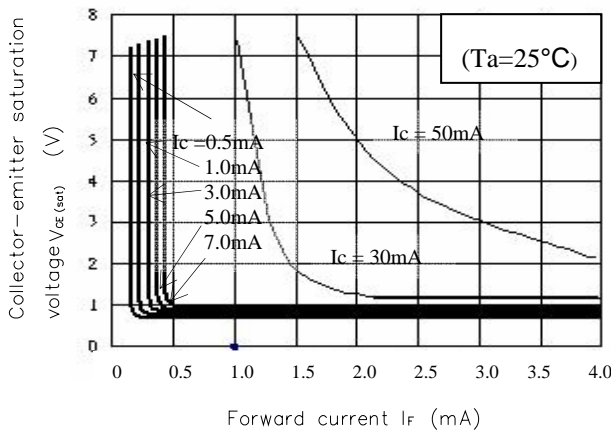
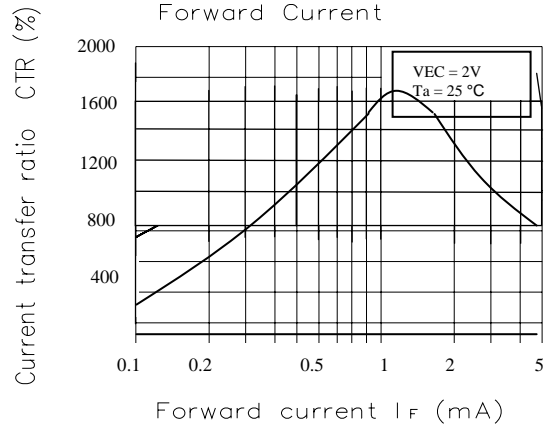

Fig.4 Current transfer Ratio vs. Forward Current



Technical Data Sheet  
Photocoupler

**EL815 Series**

Fig.5 Forward Current vs. Forward Voltage

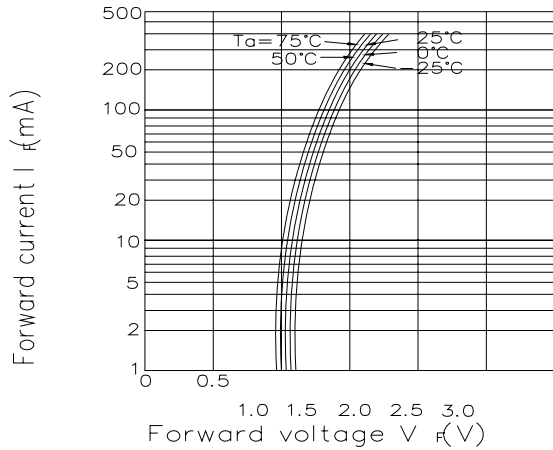

Fig.6

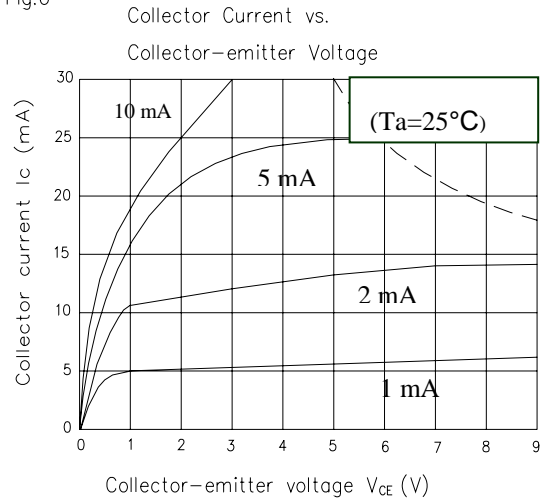

Fig.7

Relative Current Transfer Ratio vs. Ambient Temperature

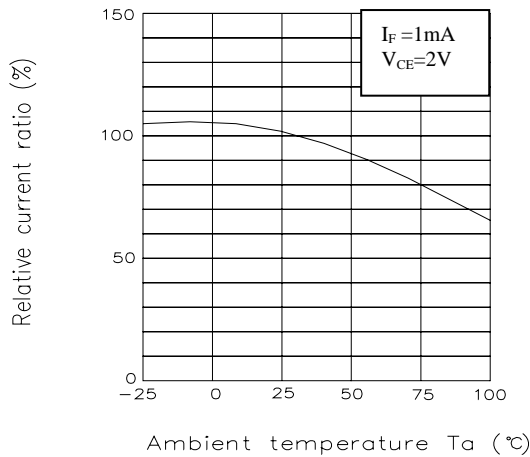
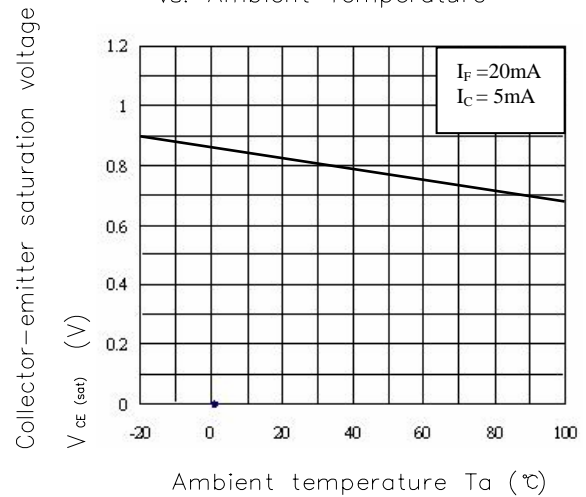

Fig.8

Collector-emitter Saturation Voltage vs. Ambient Temperature



Technical Data Sheet  
Photocoupler

**EL815 Series**

Fig.9 Collector Dark Current vs. Ambient Temperature

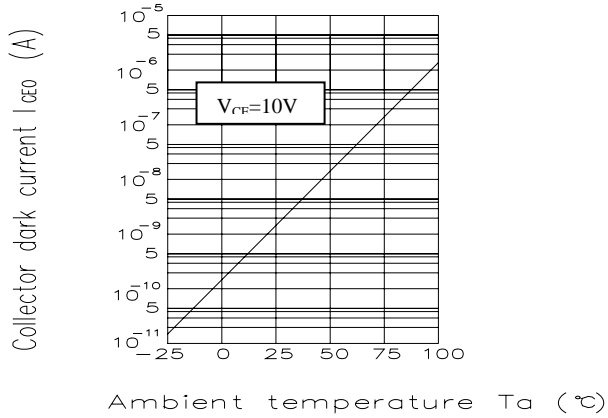

Fig.10 Response Time vs. Load Resistance

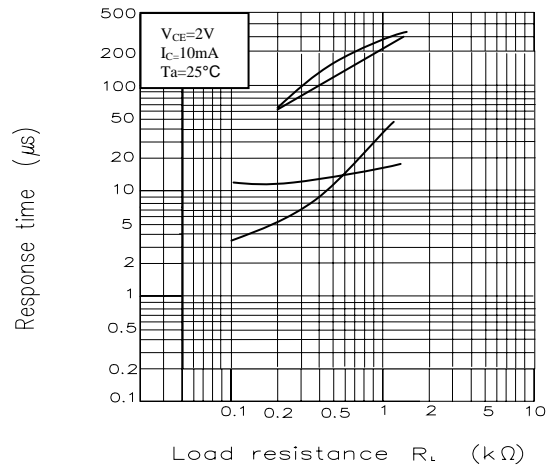
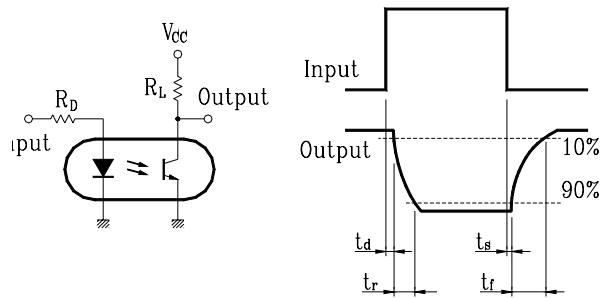
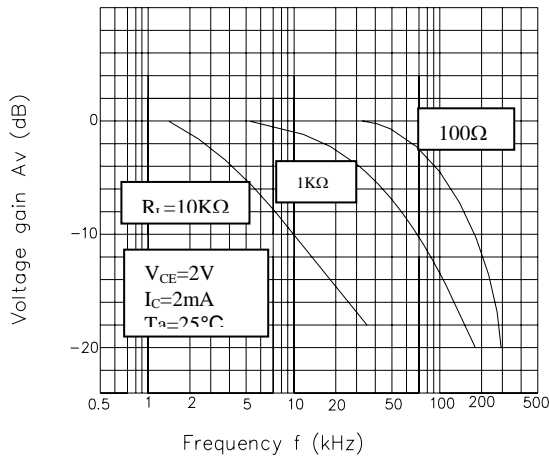

Fig.11 Frequency Response





**Technical Data Sheet  
Photocoupler**
**EL815 Series**
**RELIABILITY PLAN**

- The reliability of products shall be satisfied with items listed below.

Confidence level : 90 % , LTPD : 10 %

Classification	Test Item	Description & Condition	(Acc.) Sample	Failure Criteria	Reference Standard
<b>Endurance test</b>	Operation Life *	Ta = 25 ± 3°C IR: If = 50 mA Pt: Pc = 130 mW ( Vf=1.4v) , 1000 hrs	0 / 22	CTR shift > 1.2  Vf > U* 1.0 Ir > U * 1.0 Vce(sat) >U*1.0  Bvceo < L*1.0 Bveco < L*1.0  L :Low Spec.Limit  U : Up Spec. Limit	MIL-S-750 : 1026 MIL-S-883 : 1005 JIS C 7021 : B-1
	High Temperature / High Humidity Reverse Bias (H3TRB)	Ta = 85 ± 3°C , Humi. = 85 % rh Pt: 80% * Vce (max rating) , 1000 hrs	0 / 22		JIS C 7021 : B-11
	High Temperature Reverse Bias (HTRB)	Ta = 105 ± 3°C Pt: 100% * Vce (Max rating) , 1000 hrs	0 / 22		JIS C 7021 : B-8
	Low Temperature Storage	Ta = -50 ± 3°C , 1000 hrs	0 / 22		JIS C 7021 : B-12
	High Temperature Storage	Ta = 125 ± 3°C , 1000 hrs	0 / 22		JIS C 7021 : B-10 MIL-S-883 : 1008
	Auto clamp	P = 15 PSIG , Ta = 121 °C , Humi. = 100 % rh , 48 hrs	0 / 22		JESD 22-A102-B
	<b>Environmental Test</b>	Temperature Cycling (Air to Air)	125°C ~ - 55 °C 30 ~ 30 min , 100 cycles		0 / 22
Thermal Shock (Liquid to Liquid)		125 ~ - 55°C t (dwell) = 5 min t (trans.) = 10 sec , 100 cycles	0 / 22	MIL-S-202 : 107D MIL-S-750 : 1051 MIL-S-883 :1011	
Solder Resistance		Ta = 260 ± 3°C t (dwell) = 10 ± 1 sec	0 / 22	MIL-S-750 : 2031 JIS C 7021 : A-1	
Solder Ability		Ta = 230 ± 3 °C t (dwell) = 5 ± 1 sec	0 / 22	MIL-S-883 : 2003 JIS C 7021 : A-2	

# Technical Data Sheet Photocoupler

## EL815 Series

### 1. Tube Packing Specifications ( For Dip & M Type)

#### 1. Tube

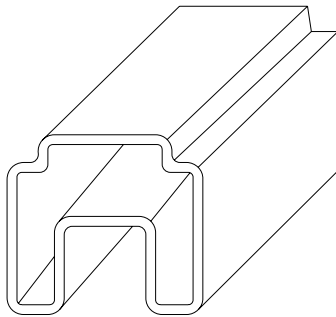

#### 2. Inner Carton

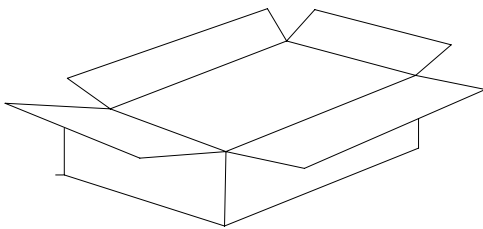

#### 3. Outside Carton

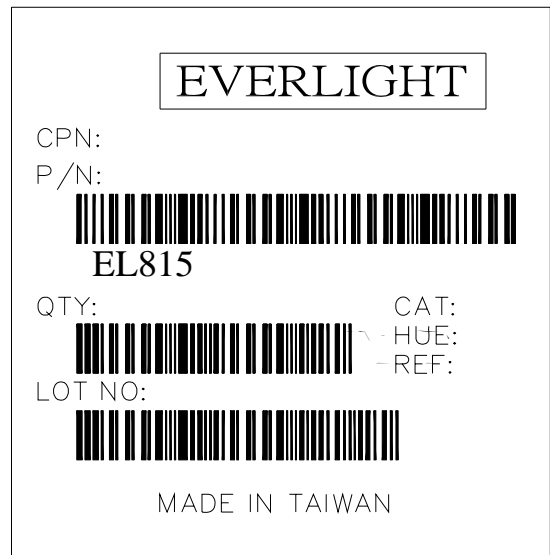
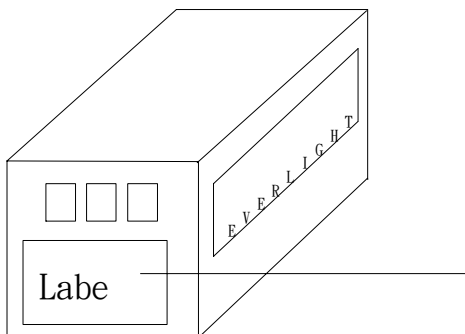

### ● Packing Quantity

1. 100 Pcs/ Per Tube
2. 25 Tubes / Inner Carton
3. 12 Inner Cartons / Outside Carton

**Technical Data Sheet  
Photocoupler**

**EL815 Series**

**1. Tape & Reel Packing Specifications**

1. Tape & Reel (For S Type only)

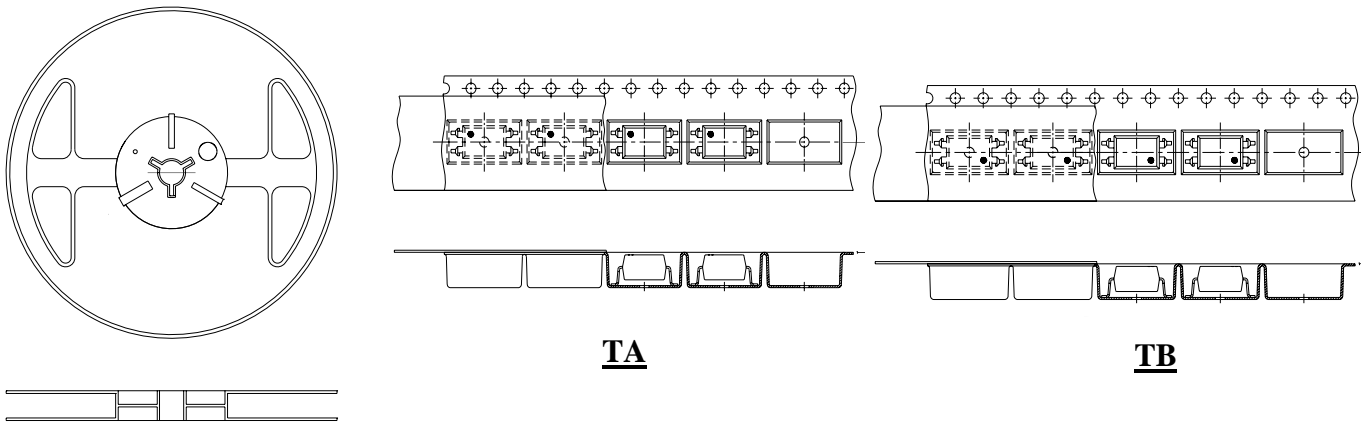

**2. Inner Carton**

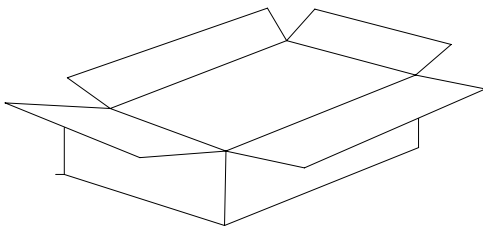

**3. Outside Carton**

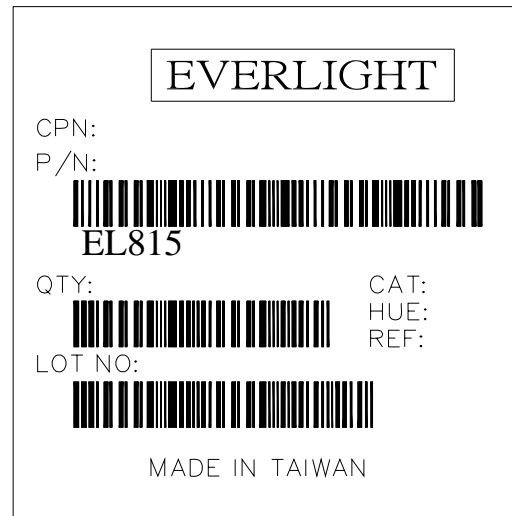
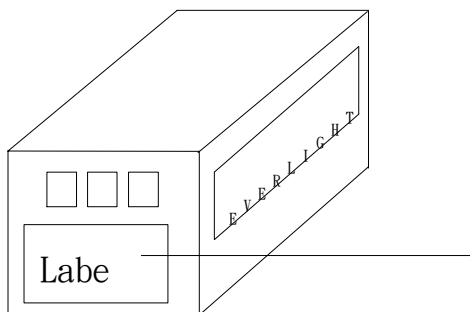

● **Packing Quantity**

1. 1,000 Pcs / Per Reel
2. 3 Reels / Inner Carton
3. 10 Inner Cartons / Outside Carton