

Technical Data Sheet (Preliminary)

Surface Mount Device

ELSS-205/6USRWA/S530-A2

Features

- Small size.
- Low power consumption.
- Categorized for luminous intensity.
- Suitable for all SMT assembly methods
- Pb free.
- The product itself will remain within RoHS compliant version.

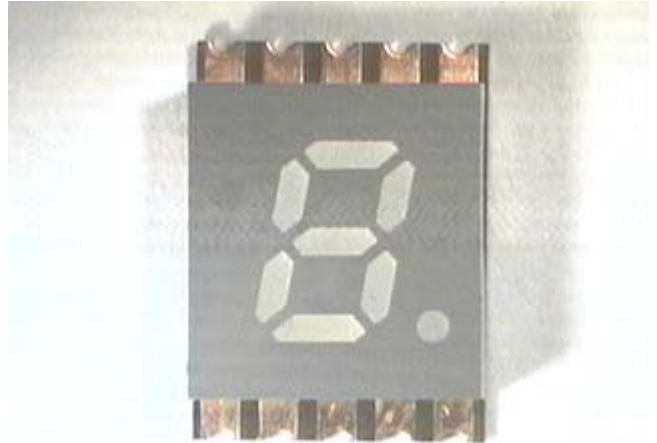

Descriptions

- The ELSS-205/6 series is a 5.08mm (0.2") height seven segment display.
- These displays provide excellent reliability in bright ambient light.
- These devices are made with white segments and gray surface.

Applications

- Audio equipment
- Office Automation Equipment
- Instrument panels
- Test and Measurement Equipment
- Digital read out display

Device Selection Guide

Chip		PART NO.
Material	Emitted Color	
AlGaInP	Super Red	ELSS-205/6USRWA/S530-A2

Technical Data Sheet (Preliminary)

Surface Mount Device

ELSS-205/6USRWA/S530-A2

Package Dimensions

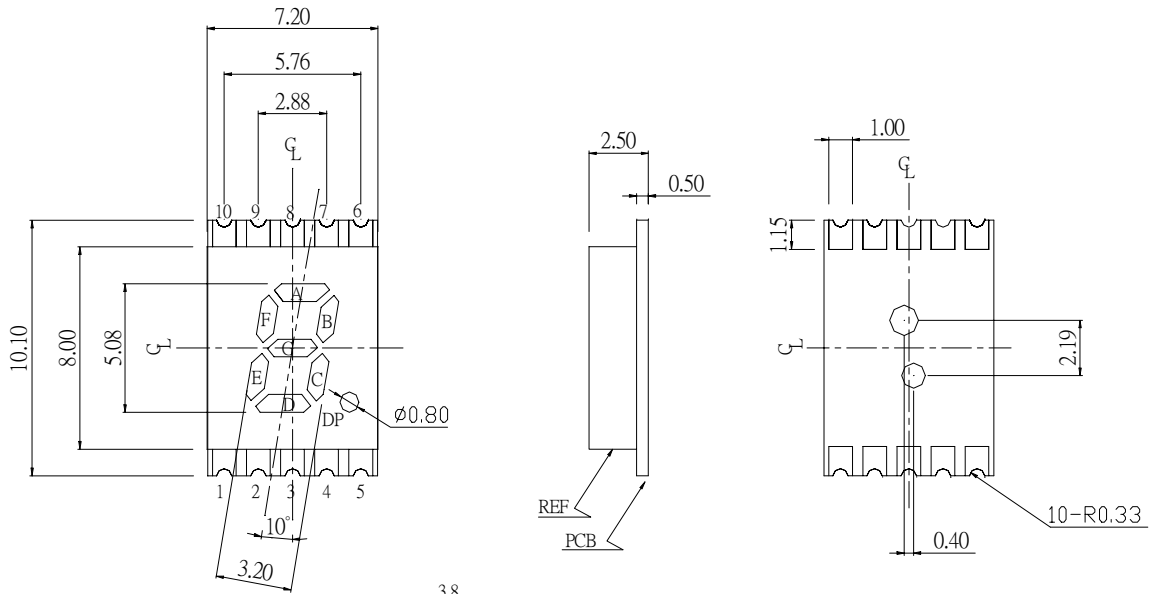

Common Cathode
SS205

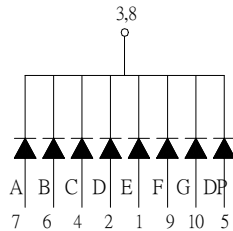

Common Anode
SS206

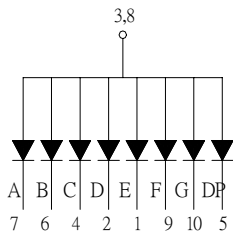

Recommended Soldering Pattern

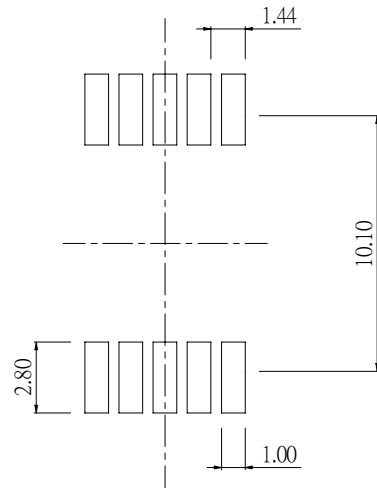

1. All dimensions are in millimeters , tolerance is 0.25mm unless otherwise noted.
2. Above specification may be changed without notice. Supplier will reserve authority on material change for above specification.

Technical Data Sheet (Preliminary)

Surface Mount Device

ELSS-205/6USRWA/S530-A2

Absolute Maximum Ratings ($T_A=25^{\circ}\text{C}$)

Parameter	Symbol	Rating	Unit
Reverse Voltage	V_R	5	V
Forward Current	I_F	25	mA
Operating Temperature	T_{opr}	-40 ~ +85	$^{\circ}\text{C}$
Storage Temperature	T_{stg}	-40 ~ +100	$^{\circ}\text{C}$
Soldering Temperature	T_{sol}	260(for 5 sec)	$^{\circ}\text{C}$
Electrostatic Discharge	ESD	2000	V
Power Dissipation	P_D	60	mW
Peak Forward Current(Duty 1/10 @ 1KHz)	$I_{F(peak)}$	160	mA

Electronic Optical Characteristics :

Parameter		Symbol	Min.	Typ.	Max.	Unit	Condition
Luminous Intensity	Per segment	I_v	8.00	14.00	----	mcd	$I_F=10\text{mA}$
	Per decimal point		3.00	6.00	----	mcd	$I_F=10\text{mA}$
Peak Wavelength		λ_p	----	639	----	nm	$I_F=20\text{mA}$
Dominant Wavelength		λ_d	----	631	----	nm	$I_F=20\text{mA}$
Spectrum Radiation Bandwidth		$\Delta\lambda$	----	20	----	nm	$I_F=20\text{mA}$
Forward Voltage		V_F	----	2.0	2.4	V	$I_F=20\text{mA}$
Reverse Current		I_R	----	----	10	μA	$V_R=5\text{V}$



Technical Data Sheet (Preliminary)

Surface Mount Device

ELSS-205/6USRWA/S530-A2

Typical Electro-Optical Characteristic Curves:

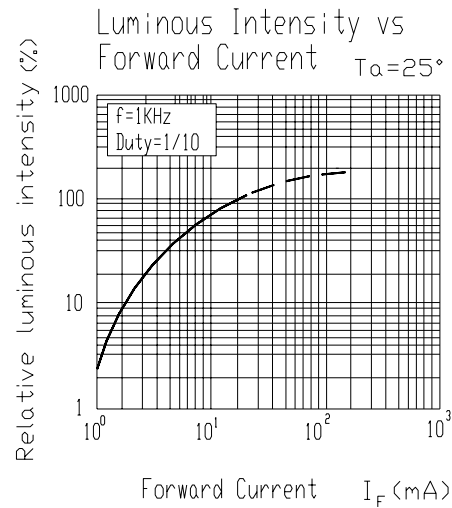
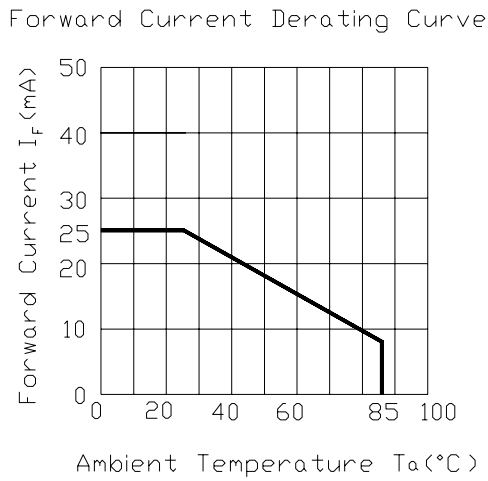
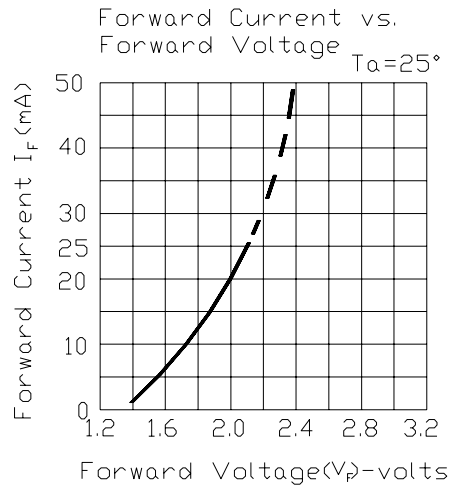
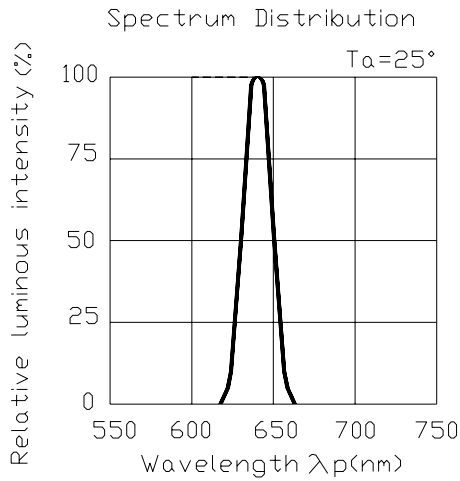

Technical Data Sheet (Preliminary)

Surface Mount Device

ELSS-205/6USRWA/S530-A2

Reliability Test Items And Conditions:

NO	Item	Test Conditions	Test Hours/Cycle	Sample Size	Ac/Re
1	Solder Heat	TEMP : 260°C ± 5 °C	5 sec	22 PCS	0/1
2	Temperature Cycle	H : +85°C 30min ∫ 5 min L : -55°C 30min	50 cycles	22 PCS	0/1
3	Thermal Shock	H : +100°C 5min ∫ 10 sec L : -10°C 5min	50 cycles	22 PCS	0/1
4	High Temperature Storage	TEMP : 100°C	1000 h	22 PCS	0/1
5	Low Temperature Storage	TEMP : -55°C	1000 h	22 PCS	0/1
6	DC Operating Life	I _F = 10mA	1000 h	22 PCS	0/1
7	High Temperature / High Humidity	85°C/85% RH	1000 h	22 PCS	0/1

Products are evaluated according to the above standard reliability criteria.

Technical Data Sheet (Preliminary)

Surface Mount Device

ELSS-205/6USRWA/S530-A2

Precautions For Use

1. Over-current-proof

Customer must apply resistors for protection , otherwise slight voltage shift will cause big current change (Burn out will happen).

2. Storage

2.1 Do not open moisture proof bag before the products are ready to use.

2.2 Before opening the package, the device should be kept at 30°C or less and 90%RH or less.

2.3 The device should be used within a year.

2.4 After opening the package, the device should be kept at 30°C or less and 70%RH or less.

2.5 The device should be used within 168 hours (7 days) after opening the package.

2.6 If the moisture absorbent material (silica gel) has faded away or the device have exceeded the storage time, baking treatment should be performed using the following conditions.

Baking treatment : 60±5°C for 24 hours.

3. Soldering Condition

3.1 Pb-free solder temperature profile

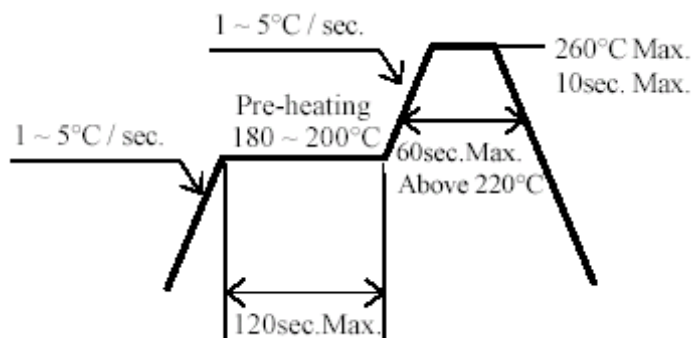

3.2 Reflow soldering should not be done more than two times.

3.3 When soldering, do not put stress on the device during heating.

3.4 After soldering, do not warp the circuit board.

Technical Data Sheet (Preliminary)

Surface Mount Device

ELSS-205/6USRWA/S530-A2

4. Soldering Iron

Each terminal is to go to the tip of soldering iron temperature less than 280°C for 3 seconds within once in less than the soldering iron capacity 25W. Leave two seconds and more intervals, and do soldering of each terminal. Be careful because the damage of the product is often started at the time of the hand solder.

5. Repairing

Repair should not be done after the device have been soldered. When repairing is unavoidable, a double-head soldering iron should be used (as below figure). It should be confirmed beforehand whether the characteristics of the device will or will not be damaged by repairing.

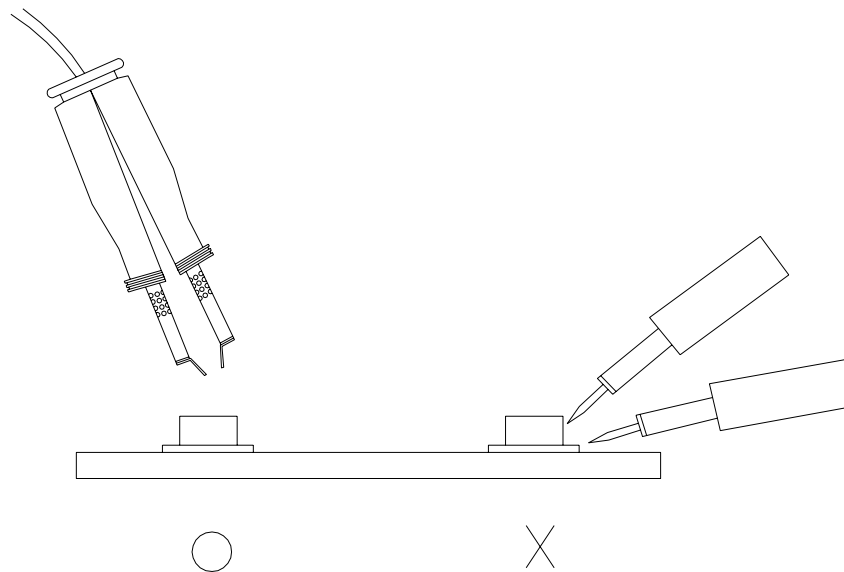
**EVERLIGHT ELECTRONICS CO., LTD.**

Office: No 25, Lane 76, Sec 3, Chung Yang Rd,
Tucheng, Taipei 236, Taiwan, R.O.C

Tel: 886-2-2267-2000, 2267-9936

Fax: 886-2-2267-6244, 2267-6189, 2267-6306

<http://www.everlight.com>